

S900 Configuration



9900

Walk-In / Wetroom

Montageanleitung:

siehe S900 Seite 5-6

Instruction Manual:

use S900 page 5-6



2100

Frontestieg mit Seitenteil/ Front Entry with Side-Panel

Montageanleitung:

siehe S100 Seite 2-4 und S900 Seite 2-4

Instruction Manual:

use S100 page 2-4 and S900 page 2-4



2200

Frontestieg mit Seitenteil/ Front Entry with Side-Panel

Montageanleitung:

siehe S200 Seite 2-4 und S900 Seite 2-4

Instruction Manual:

use S200 page 2-4 and S900 page 2-4



2300

Frontestieg mit Seitenteil/ Front Entry with Side-Panel

Montageanleitung:

siehe S300 Seite 2-4 und S900 Seite 2-4

Instruction Manual:

use S300 page 2-4 and S900 page 2-4



2400

Frontestieg mit Seitenteil/ Front Entry with Side-Panel

Montageanleitung:

siehe S400 Seite 2-4 und S900 Seite 2-4

Instruction Manual:

use S400 page 2-4 and S900 page 2-4

S900

Achtung! Gläser niemals ungeschützt auf den Boden stellen.
Verletzung der Glaskante führt zu Glasbruch.
Die Befestigungsmaterialien sind der jeweiligen Beschaffenheit der Wand anzupassen. Eine ausreichende Befestigung ist zu gewährleisten.

Caution! Never put glass walls on the floor without protection.
Damaging the glass edges results in breaking of the glass.
In each case, the fixing material must be suitable for the construction of the corresponding wall. Secure attachment must be warranted.

ข้อควรระวัง! ห้ามวางผนังกระจกบนพื้นโดยไม่มีอุปกรณ์ป้องกันหาก
ขอบ / มุมกระจกเสียหาย กระจกอาจแตกได้ โดยวัสดุยึดต้องเหมาะสม
กับ โครงสร้างของผนังแต่ละประเภท

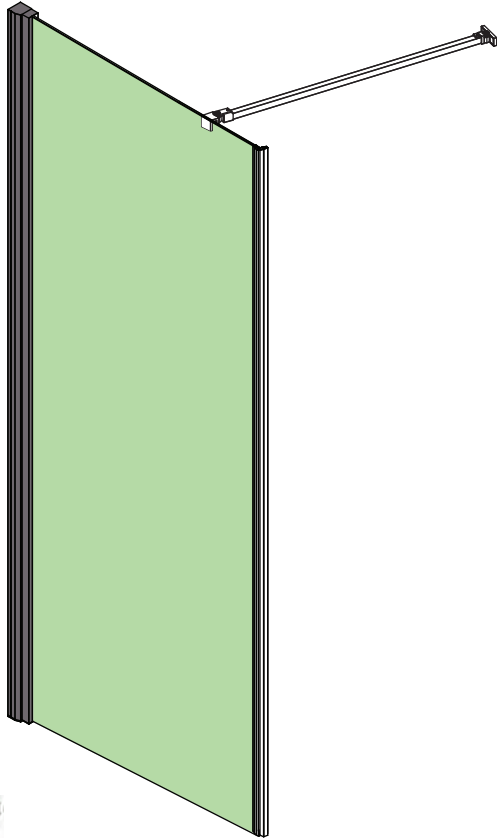

Mitgeliefertes Montagmaterial
supplied assembly material
ชิ้นส่วนอุปกรณ์ในชุดติดตั้ง

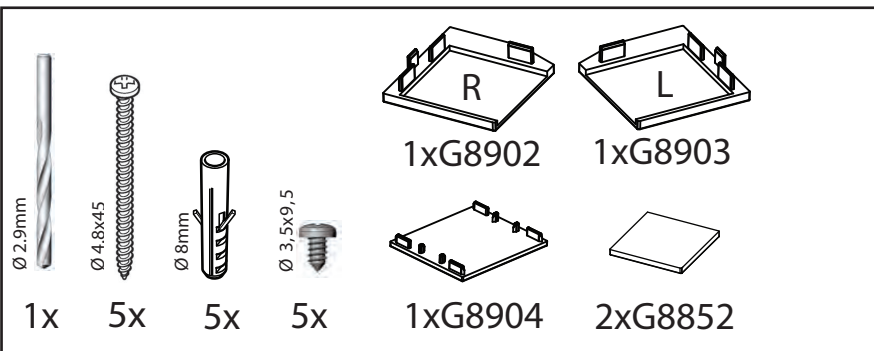

Zum Aufbau benötigen Sie
for mounting you need
pour l'installation il vous faut



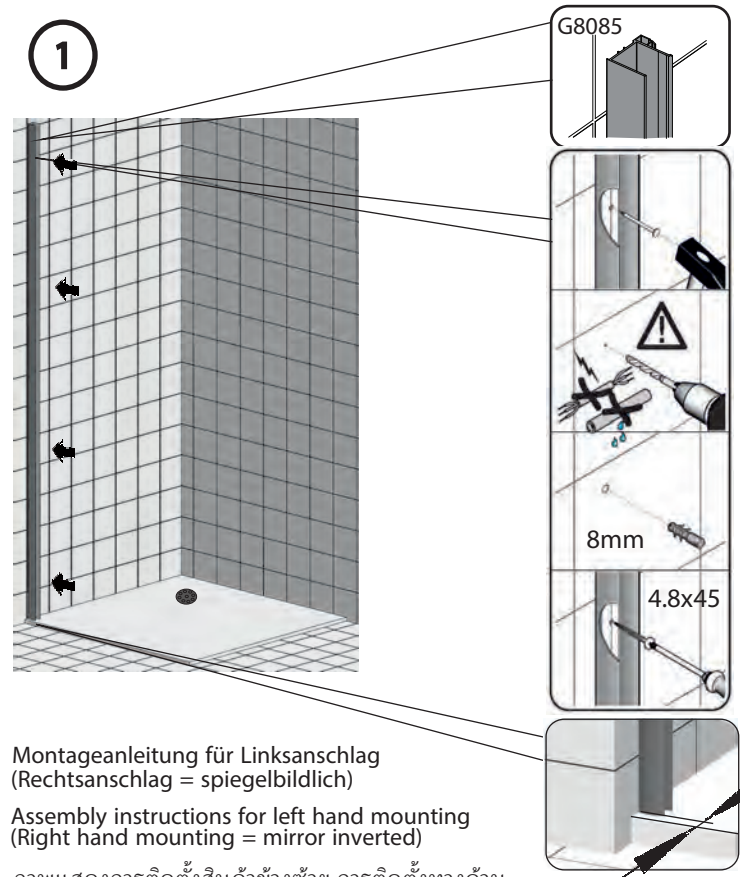
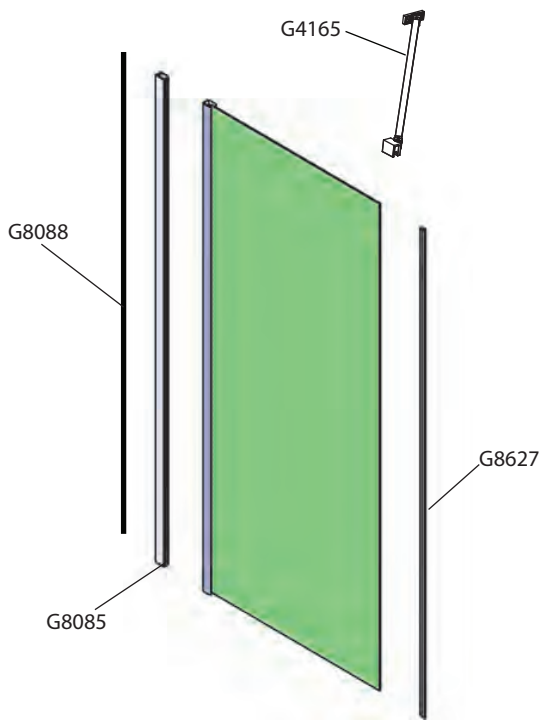

Montageanleitung für Linksanschlag
(Rechtsanschlag = spiegelbildlich)

Assembly instructions for left hand mounting
(Right hand mounting = mirror inverted)

ภาพแสดงการติดตั้งสินค้าข้างซ้าย การติดตั้งทางด้านขวาสามารถติดตั้งได้ โดยเทียบทิศทางตรงกันข้าม

2 !

Magnetprofil G8627 nur unten kürzen.
Magnet profile G8627 shorten at bottom
Profilé magnétique accourcir au bout au-dessous seulement

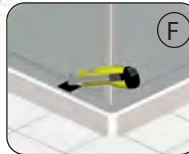
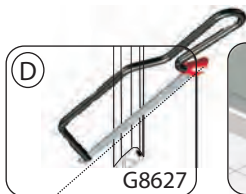
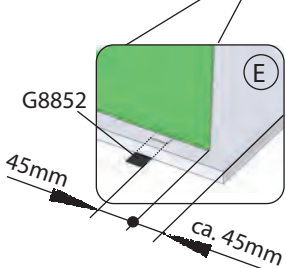
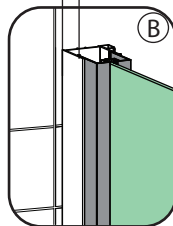
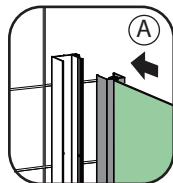
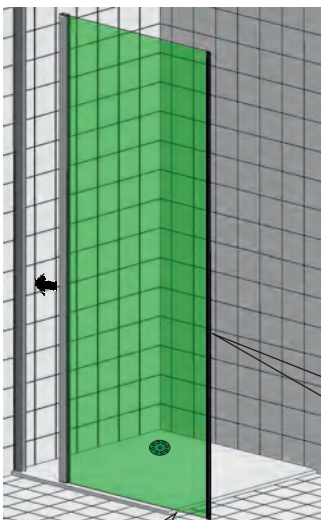

3

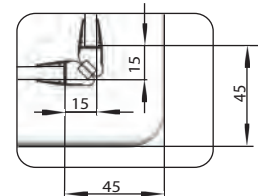
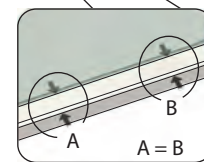
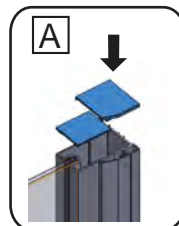
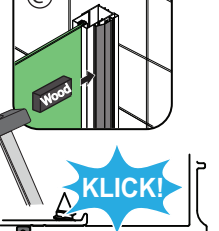
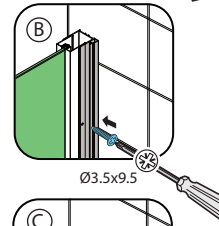
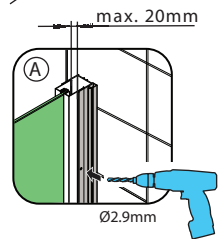
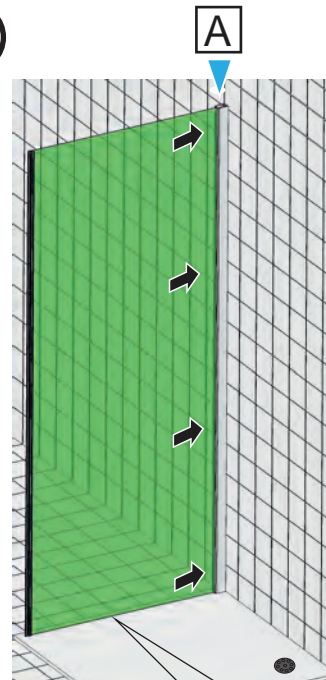

S900

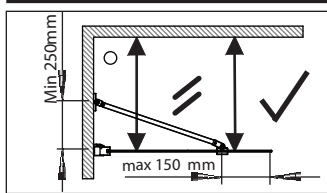
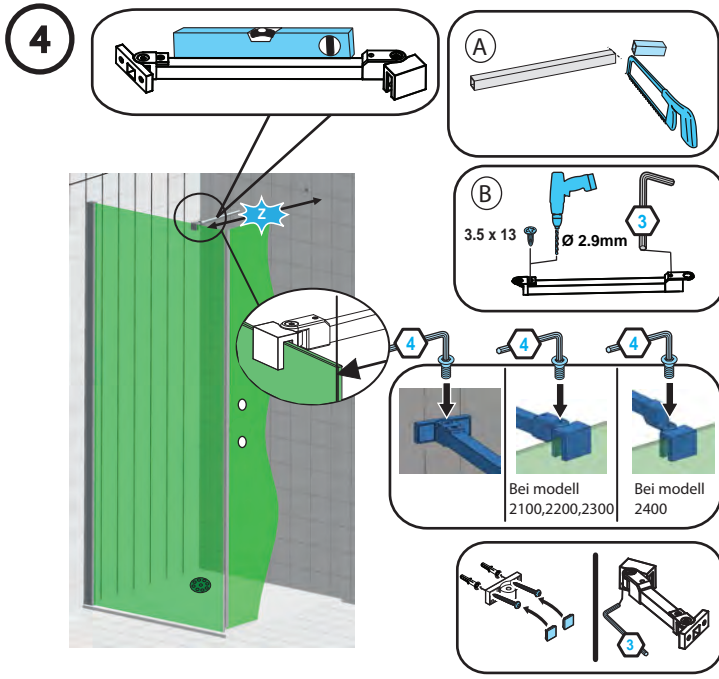

Bei modell 2200, 2300

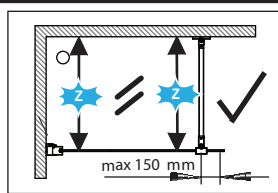

Bei modell 2100, 2400

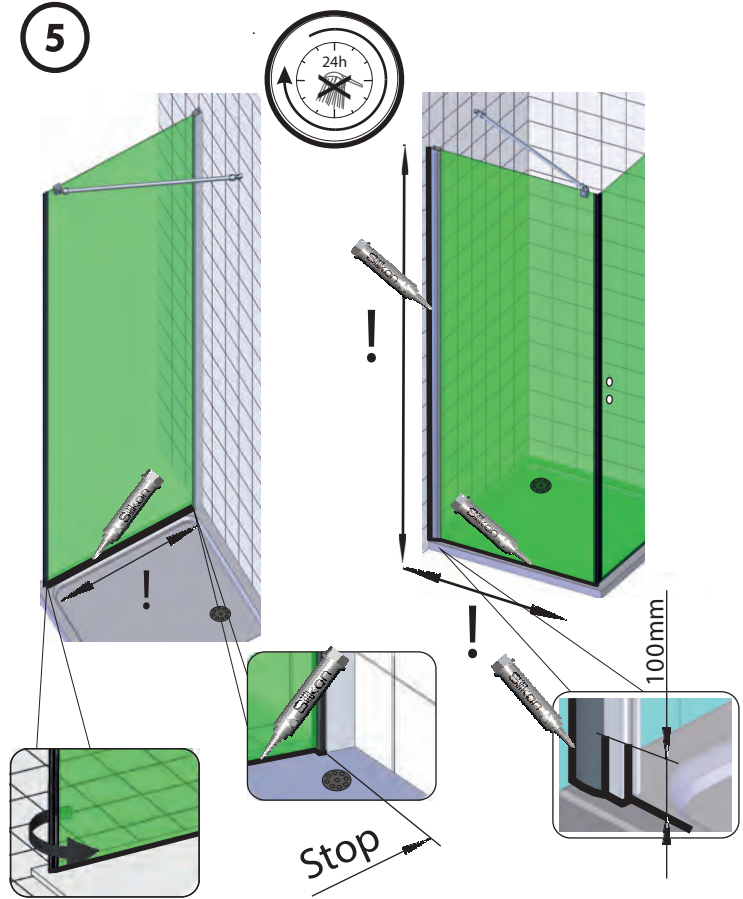

Montage auf Duschtasse

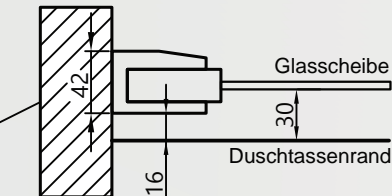
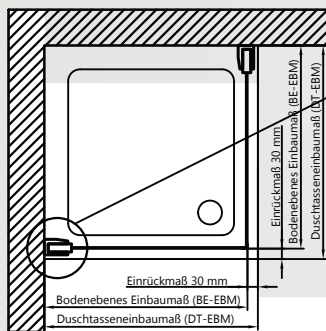

DT	DT-EBM	BE-EBM
800	785 - 805	755 - 775
900	885 - 905	855 - 875
1000	985 - 1005	955 - 975

Montage Bodeneben

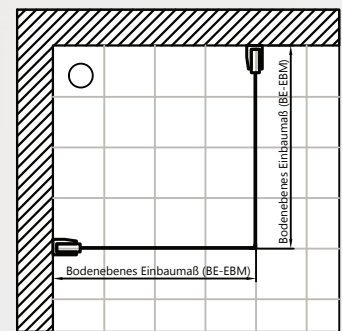

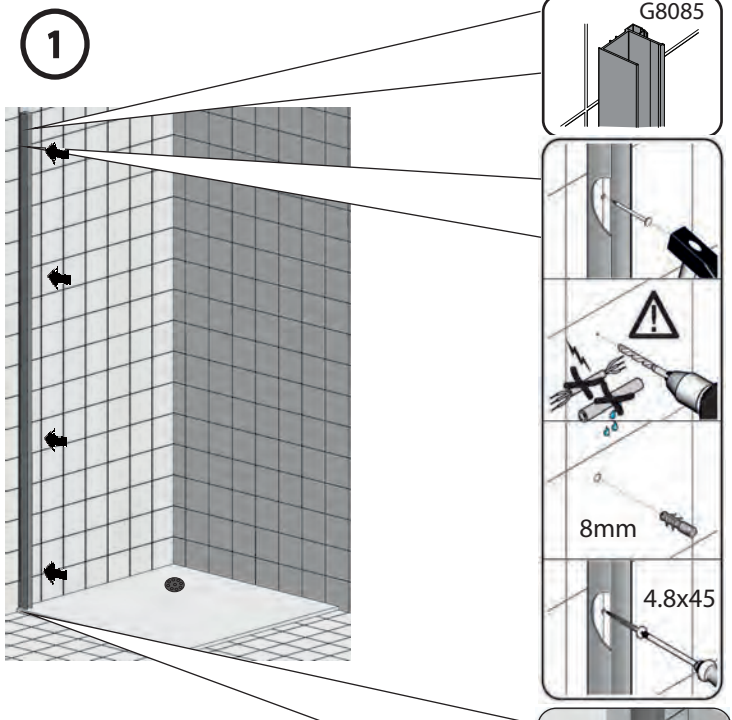
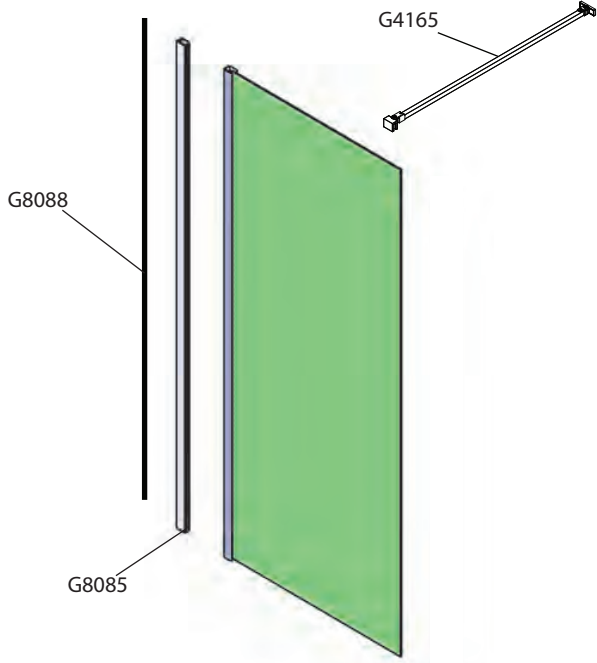

Montageanleitung für Linksanschlag
(Rechtsanschlag = spiegelbildlich)
Assembly instructions for left hand mounting
(Right hand mounting = mirror inverted)

ภาพแสดงการติดตั้งสินค้าข้างซ้าย การติดตั้งทางด้านขวาสามารถติดตั้งได้ โดยเทียบทิศทางตรงกันข้าม

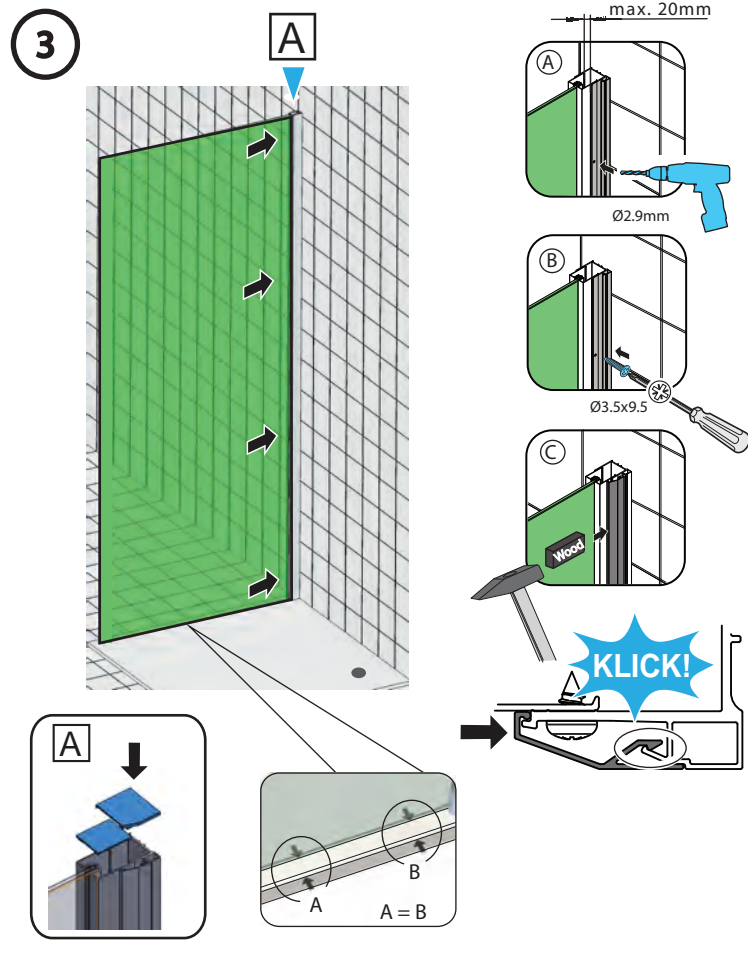
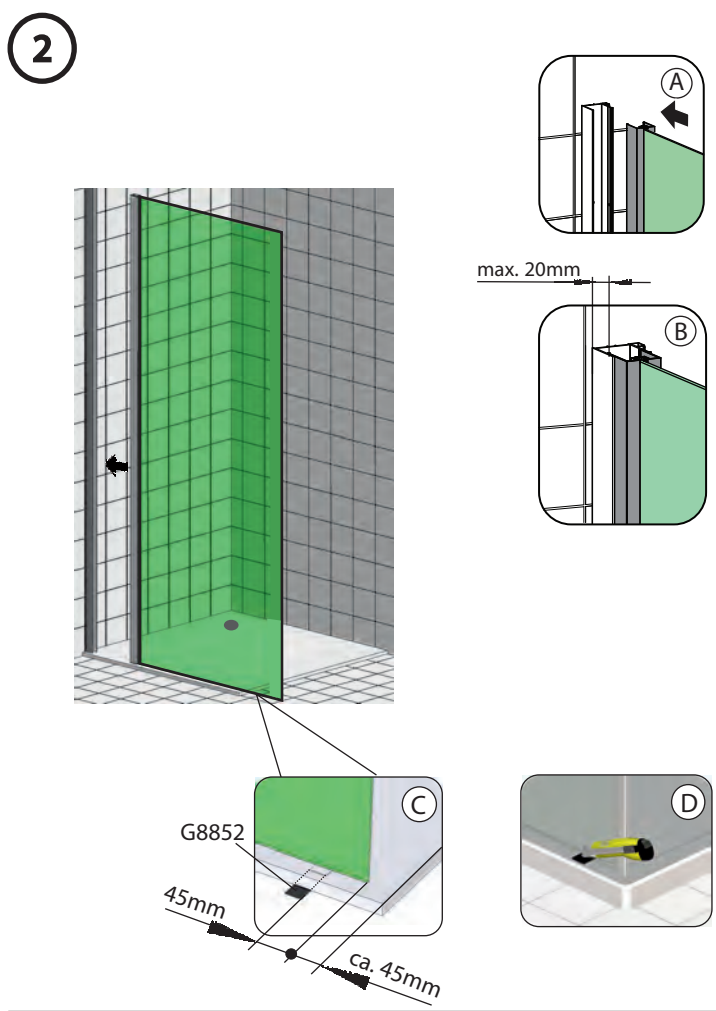

S900

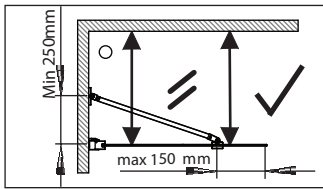
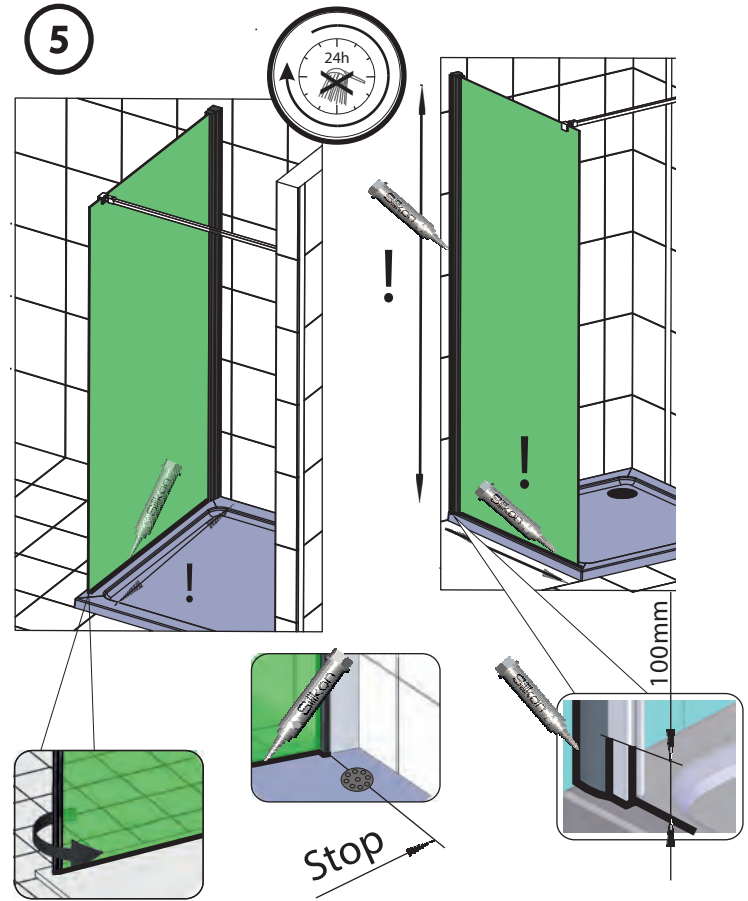
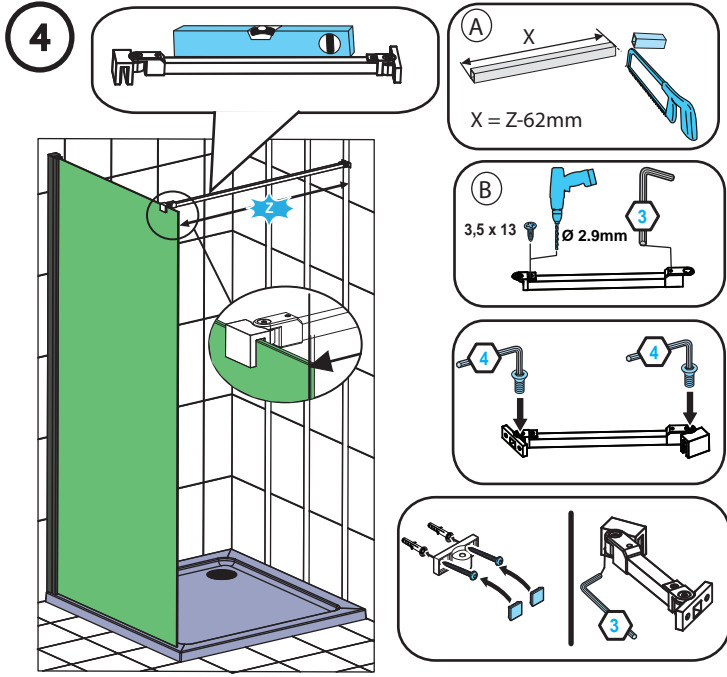

Bei modell 9900

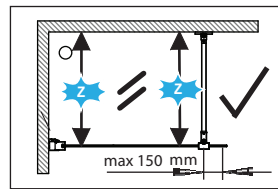

Bei modell 9900

Montage auf Duschtasse

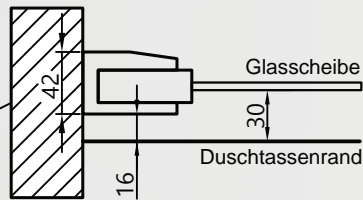
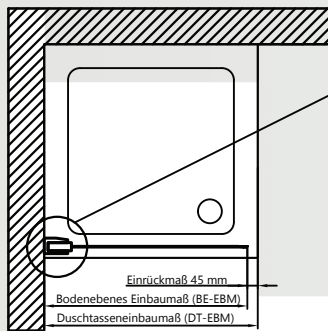

DT	DT-EBM	BE-EBM
800	785 - 805	740 - 760
900	885 - 905	840 - 860
1000	985 - 1005	940 - 960

Montage Bodeneben

